



AC 225

SCOTSMAN®

ICE SYSTEMS

- AC 25
- AC 45
- AC 55
- AC 85
- AC 105
- AC 125
- AC 175
- AC 225

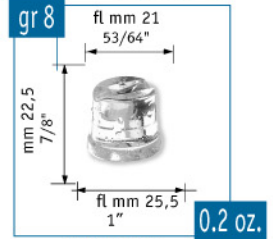
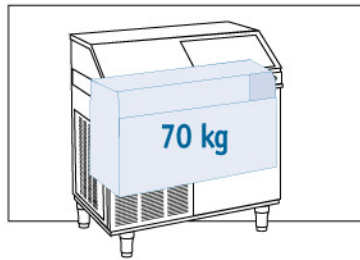
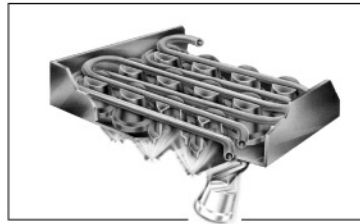

AC S 225



AC M 225



AC L 225



SS AISI 304

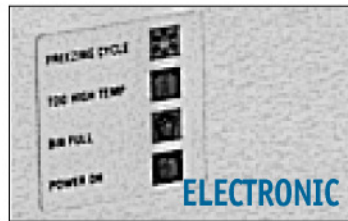
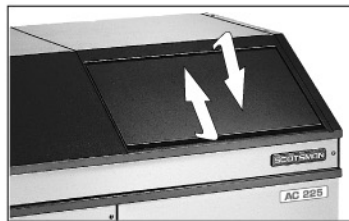

ELECTRONIC

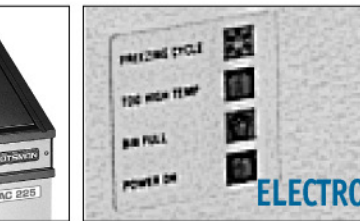

70 kg

Automatic
Gourmet-Cube
Ice Machine

Machine
Automatique
à Glaçons
Gourmet

Automatischer
Gourmetkegel-
eisbereiter

Màquina
Automàtica
Fabricadora
de Cubitos
Gourmet

Produttore
Automatico
di Ghiaccio
a Cubetti
Gourmet

	+C _i -C _i	24h [kg] [lbs] N _i	[kg] [lbs] N _i	[v/Hz/ph]	[HxWxD mm]	[HxWxD inches]	120 mm (4 3/4") 	[H mm] [H inches]	R
AC S 225 A		130 286 16250	70 154 8750	230/50/1	1001x1078x617,5	39 13/32"x42 7/16"x24 5/16"	H=1001+120 39 13/32"+4 3/4"	R 404 a	
AC S 225 W		135 297 16900	70 154 8750	230/50/1	1001x1078x617,5	39 13/32"x42 7/16"x24 5/16"	H=1001+120 39 13/32"+4 3/4"	R 404 a	
AC M 225 A		145 319 7250	70 154 3500	230/50/1	1001x1078x617,5	39 13/32"x42 7/16"x24 5/16"	H=1001+120 39 13/32"+4 3/4"	R 404 a	
AC M 225 W		150 330 7500	70 154 3500	230/50/1	1001x1078x617,5	39 13/32"x42 7/16"x24 5/16"	H=1001+120 39 13/32"+4 3/4"	R 404 a	
AC L 225 A		138 303 3940	70 154 2000	230/50/1	1001x1078x617,5	39 13/32"x42 7/16"x24 5/16"	H=1001+120 39 13/32"+4 3/4"	R 404 a	
AC L 225 W		142 312 4050	70 154 2000	230/50/1	1001x1078x617,5	39 13/32"x42 7/16"x24 5/16"	H=1001+120 39 13/32"+4 3/4"	R 404 a	

2

Years Warranty
Ans de Garantie
Jahre Garantie
Años de Garantía
Anni di Garanzia

Subject to certain limitations and exclusions
Assujettie aux limites et exclusions prescrites
Abhängig von Bestimmten Einschränkungen und Ausnahmen
Sujeta a ciertas limitaciones y exclusiones.
Soggetta ad alcune limitazioni ed esclusioni

This product qualifies for the following listings:



ADV - AC225 - 5/00

AC 225

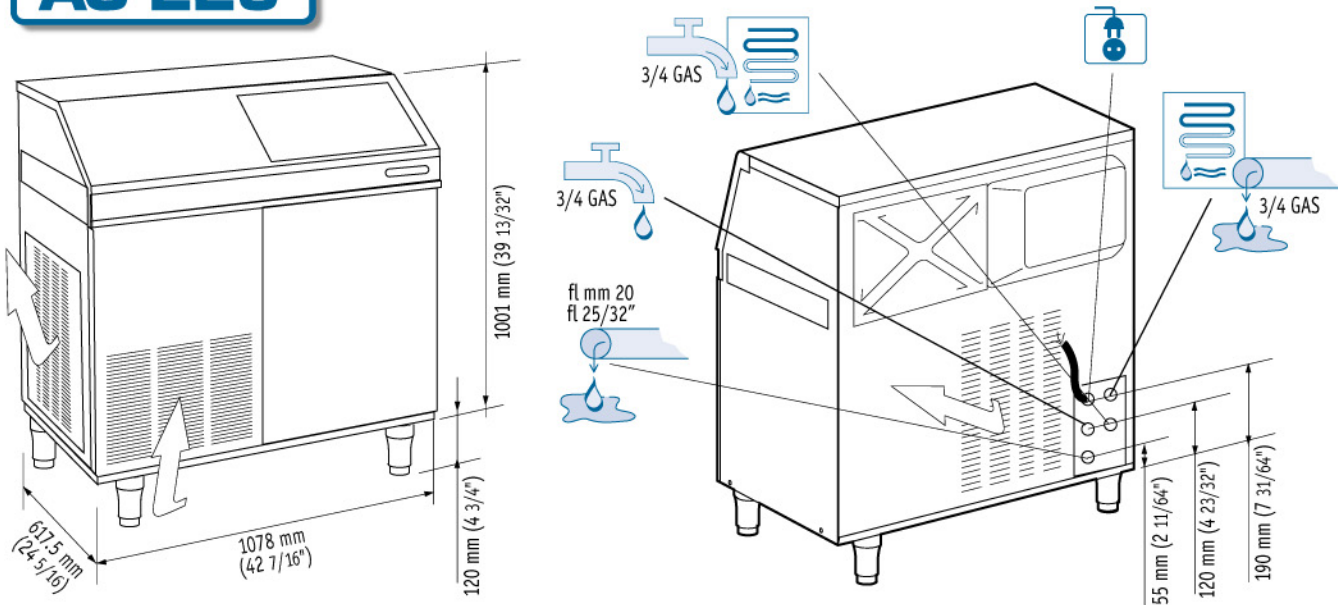

	+C _i -C _i					24h		32°C 90°F 21°C 70°F				
		[Btu/h] [kcal/h]	[flmm]	[W]	FUSE	[kWh]	[l/h]	[gal/h]	[kg]	[lbs]	[kg]	[lbs]
AC S 255 A		8900 2244	3 x 1,5	1100	16	22	10	2.6	90	198	105	231
AC S 2255 W		8900 2244	3 x 1,5	1100	16	22	100	26	90	198	105	231
AC M 225 A		8900 2244	3 x 1,5	1100	16	22	10	2.6	90	198	105	231
AC M 225 W		8900 2244	3 x 1,5	1100	16	22	100	26	90	198	105	231
AC L 225 A		8900 2244	3 x 1,5	1100	16	22	10	2.6	90	198	105	231
AC L 225 W		8900 2244	3 x 1,5	1100	16	22	100	26	90	198	105	231

ACM 225 AIR



°F	90°	70°	60°	50°	
°C	32°	21°	15°	10°	
50°	257	288	304	319	lbs
10°	117	131	138	145	kg
70°	251	282	297	312	lbs
21°	114	128	135	142	kg
90°	211	242	257	273	lbs
32°	96	110	117	124	kg
100	187	218	233	249	lbs
38°	85	99	106	113	kg

ACM 225 WATER



°F	90°	70°	60°	50°	
°C	32°	21°	15°	10°	
50°	268	299	315	330	lbs
10°	122	136	143	150	kg
70°	262	293	308	323	lbs
21°	119	133	140	147	kg
90°	255	286	301	317	lbs
32°	116	130	137	144	kg
100	242	273	288	304	lbs
38°	110	124	131	138	kg



Minimum

10°C (50°F)



Maximum

40°C (103°F)



5°C (41°F)

35°C (95°F)



-10%

+10%



1 BAR
14 psi



5 BAR
70 psi

Machine requires voltage indicated on rating name plate. Failures caused by improper voltage are not considered factory defects. Scotsman products are not designed for outdoor installation. Extended periods of operation at temperatures exceeding the above limitations constitutes misuse under the terms of Scotsman Limited Warranty, resulting in a loss.

La machine doit être raccordée conformément au voltage indiqué sur la plaque signalétique. Les éventuels dégâts causés par un non respect de cette consigne ne peuvent être considérés comme des défauts de fabrication. Les machines à glace Scotsman ne sont pas conçues pour être utilisées à l'extérieur. Le fonctionnement prolongé à des températures supérieures ou inférieures aux limites ci-dessus sont considérées comme une mauvaise utilisation dans le cadre de la garantie Scotsman.

Der Eisbereiter benötigt eine Stromspannung gemäß Geräte-Typenschild. Störungen oder Ausfälle, durch den Betrieb mit falscher Stromspannung sind keine Fabrikationsfehler und fallen nicht unter Garantie. Scotsman Eisbereiter sind nicht für die Installation im Freien geeignet. Der längere Betrieb bei Temperaturen über den obigen Grenzwerten ist eine falsche Anwendung und bedeutet den Verlust der Garantieleistung.

Los requerimientos eléctricos de la máquina están indicados en la placa de características. Los daños causados por voltajes inadecuados no son considerados defectos de fábrica. La máquinas de hielo Scotsman, no están diseñadas para trabajar a la intemperie. Largos periodos de funcionamiento a temperaturas que excedan de las limitaciones indicadas, constituyen maltrato de acuerdo con las observaciones de Scotsman.

La macchina richiede il voltaggio indicato sulla targhetta di identificazione. Danni causati da voltaggi diversi non sono considerati difetti di produzione. I prodotti Scotsman non vanno utilizzati all'aperto. Un prolungato periodo di utilizzo al di fuori delle temperature indicate non è consentito e causa l'automatico decadere della garanzia.

SCOTSMAN

ICE SYSTEMS

The One The World Relies On.™

USA, Canada, Central and South America
Scotsman Ice Systems USA
775 Corporate Woods Parkway
Vernon Hills, IL 60061
Ph: (847) 215-4550 - Fax (847) 913-9844
E-Mail: customer.service@scotsman-ice.com

Europe, Middle East and Africa
Scotsman Europe - Frimont S.p.A.
Via Puccini, 22
20010 Bettolino di Pogliano (Milano) Italy
Ph: (+39) 02-93960208 - Fax: (+39) 02-93960201
E-Mail: scotsman.europe@frimont.net.it

Asia and Pacific
Scotsman Ice Systems-Frimont S.p.A. (R.O.)
321 Orchard Road #08-05
Singapore 238866
Ph: (+65) 738 5393 - Fax: (+65) 738 1959
E-mail: scotsice@singnet.com.sg

China
Scotsman Ice Systems
258 Tong Ren Road Golden Tower 7A
Shanghai - 200040 Peoples' Republic of China
Ph: (+86) 21-62476056-Fax: (+86) 21-62476126
E-mail: scotsmansh@online.sh.cn

