



MC 15

SCOTSMAN

ICE SYSTEMS

MC 15
MC 45
MC1210



MC 15 with B 350

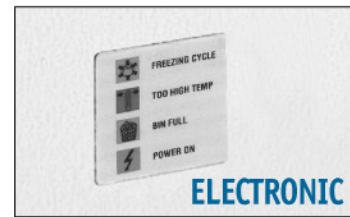
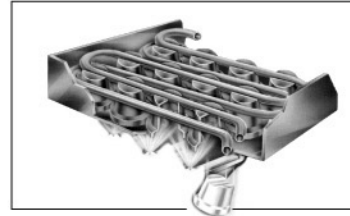

ELECTRONIC

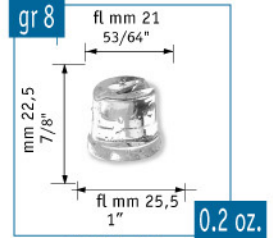

MC S 15



MC M 15



MC L 15

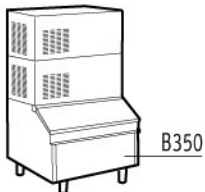

B350

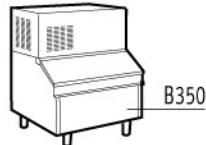

B350



B550

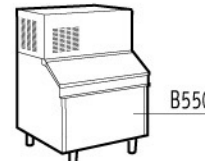

B550

Modular
Gourmet-Cube
Ice Machine

Machine
Modulaire à
Glaçons
Gourmet

Kombi
Gourmetkegel-
eisbereiter

Màquina
Modulare
Fabricadora
de Cubitos
Gourmet

Produttore
Modulare di
Ghiaccio a
Cubetti Gourmet

	+C _i -C _i	24h [kg] [lbs] N _i	B350 B550 [kg] [lbs] N _i [kg] [lbs] N _i	 [v/Hz/ph]	 [WxDxH mm] [WxDxH inches]	R
MC L 15 A		162 357 4400	150 330 4300 230 506 6550	230/50/1 - 400/50/3N	1073x534x500 42 1/4"x21"x19 21/32"	R 404 a
MC L 15 W		164 362 4400	150 330 4300 230 506 6550	230/50/1 - 400/50/3N	1073x534x500 42 1/4"x21"x19 21/32"	R 404 a
MC M 15 A		170 374 8500	150 330 7500 230 506 11500	230/50/1 - 400/50/3N	1073x534x500 42 1/4"x21"x19 21/32"	R 404 a
MC M 15 W		172 378 8600	150 330 7500 230 506 11500	230/50/1 - 400/50/3N	1073x534x500 42 1/4"x21"x19 21/32"	R 404 a
MC S 15 A		153 337 19000	150 330 18700 230 506 28750	230/50/1 - 400/50/3N	1073x534x500 42 1/4"x21"x19 21/32"	R 404 a
MC S 15 W		155 340 19300	150 330 18750 230 506 28750	230/50/1 - 400/50/3N	1073x534x500 42 1/4"x21"x19 21/32"	R 404 a

2

Years Warranty
Ans de Garantie
Jahre Garantie
Años de Garantía
Anni di Garanzia

Subject to certain limitations and exclusions
Assujettie aux limites et exclusions prescrites
Abhängig von Bestimmten Einschränkungen und Ausnahmen
Sujeta a ciertas limitaciones y exclusiones.
Soggetta ad alcune limitazioni ed esclusioni

This product qualifies for the following listings:



Models and specifications are subject to change without notice - Les modeles et les caracteristiques des appareils peuvent être changés sans préavis - Wir behalten das Recht vor jederzeit Änderungen der Modelle und der technischen Angaben vorzunehmen.
Los modelos y las características pueden ser modificados en cualquier momento sin previo aviso - I modelli e le specifiche possono essere cambiate in qualunque momento senza preavviso

ADV MC 15 - 5/00

MC 15

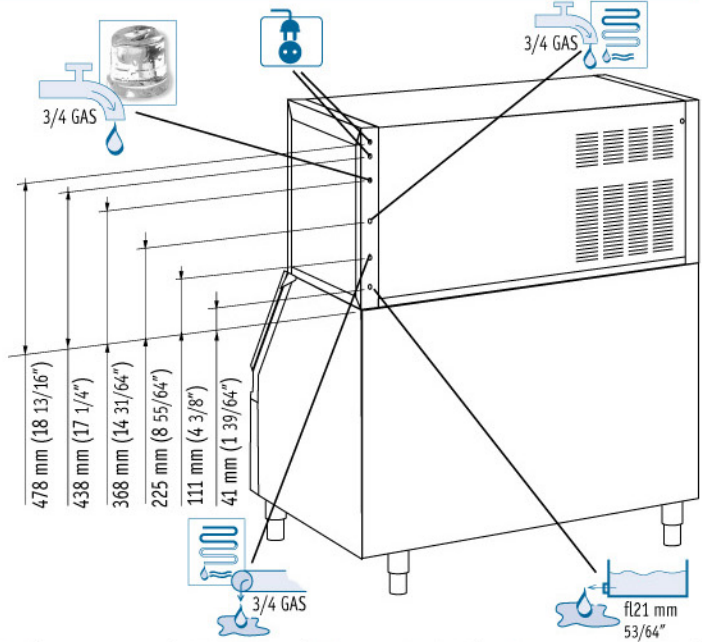
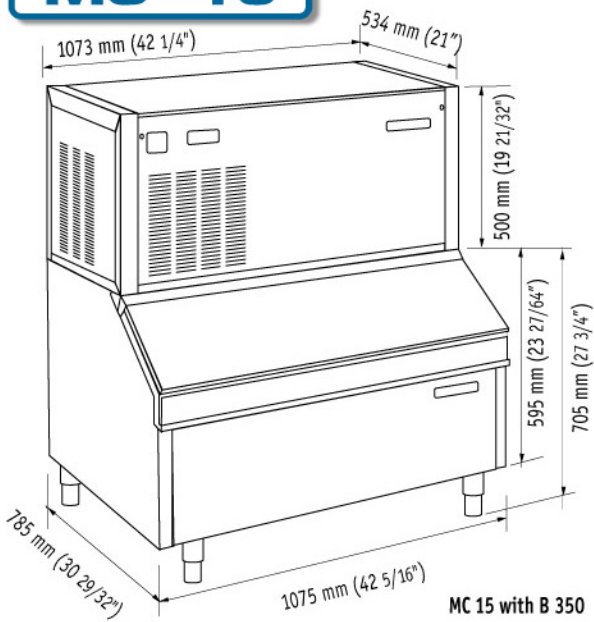

	+C _i -C _i	[Btu/h] [kcal/h]	[flmm]	[W]	FUSE	[kWh] 24h	[L/h] [gal/h]	32°C 90°F 21°C 70°F	[kg] [lbs]	[kg] [lbs]
MC L 15 A		12700 3202	3x1.5 - 5x1.5	1250	20	26	12.5 3,3		70 154	85 187
MC L 15 W		12700 3202	3x1.5 - 5x1.5	1250	20	26	116 30,6		69 152	84 185
MC M 15 A		12700 3202	3x1.5 - 5x1.5	1250	20	26	12.5 3,3		70 154	85 187
MC M 15 W		12700 3202	3x1.5 - 5x1.5	1250	20	26	116 30,6		69 152	84 185
MC S 15 A		12700 3202	3x1.5 - 5x1.5	1250	20	26	12.5 3,3		70 154	85 187
MC S 15 W		12700 3202	3x1.5 - 5x1.5	1250	20	26	116 30,6		69 152	84 185

MC M 15 AIR



°F	90°	70°	60°	50°	
°C	32°	21°	15°	10°	
50°	324	348	363	374	lbs
10°	147	158	165	170	kg
70°	315	339	352	366	lbs
21°	143	154	160	166	kg
90°	242	269	282	293	lbs
32°	110	122	128	133	kg
100	216	240	253	266	lbs
38°	98	109	115	121	kg



MC M 15 WATER



°F	90°	70°	60°	50°	
°C	32°	21°	15°	10°	
50°	317	348	363	379	lbs
10°	144	158	165	172	kg
70°	313	341	357	370	lbs
21°	142	155	162	168	kg
90°	304	337	352	366	lbs
32°	138	153	160	165	kg
100	299	330	346	357	lbs
38°	136	150	157	162	kg



Machine requires voltage indicated on rating name plate. Failures caused by improper voltage are not considered factory defects. Scotsman products are not designed for outdoor installation. Extended periods of operation at temperatures exceeding the above limitations constitutes misuse under the terms of Scotsman Limited Warranty, resulting in a loss.

La machine doit être raccordée conformément au voltage indiqué sur la plaque signalétique. Les éventuels dégâts causés par un non respect de cette consigne ne peuvent être considérés comme des défauts de fabrication. Les machines à glace Scotsman ne sont pas conçues pour être utilisées à l'extérieur. Le fonctionnement prolongé à des températures supérieures ou inférieures aux limites ci-dessus sont considérées comme une mauvaise utilisation dans le cadre de la garantie Scotsman.

Der Eisbereiter benötigt eine Stromspannung gemäß Geräte-Typenschild. Störungen oder Ausfälle, durch den Betrieb mit falscher Stromspannung sind keine Fabrikationsfehler und fallen nicht unter Garantie. Scotsman Eisbereiter sind nicht für die Installation im Freien geeignet. Der längere Betrieb bei Temperaturen über den obigen Grenzwerten ist eine falsche Anwendung und bedeutet den Verlust der Garantieleistung.

Los requerimientos eléctricos de la máquina están indicados en la placa de características. Los daños causados por voltajes inadecuados no son considerados defectos de fábrica. La máquinas de hielo Scotsman, no están diseñadas para trabajar a la intemperie. Largos periodos de funcionamiento a temperaturas que excedan de las limitaciones indicadas, constituyen maltrato de acuerdo con las observaciones de Scotsman.

La macchina richiede il voltaggio indicato sulla targhetta di identificazione. Danni causati da voltaggi diversi non sono considerati difetti di produzione. I prodotti Scotsman non vanno utilizzati all'aperto. Un prolungato periodo di utilizzo al di fuori delle temperature indicate non è consentito e causa l'automatico decadere della garanzia.

Minimum	Maximum
10°C (50°F)	40°C (103°F)
5°C (41°F)	35°C (95°F)
-10%	+10%
1 BAR 14 psi	5 BAR 70 psi

SCOTSMAN

The One The World Relies On.™

ICE SYSTEMS

USA, Canada, Central and South America
Scotsman Ice Systems USA
775 Corporate Woods Parkway
Vernon Hills, IL 60061
Ph: (847) 215-4550 - Fax (847) 913-9844
E-Mail: customer.service@scotsman-ice.com

Europe, Middle East and Africa
Scotsman Europe - Frimont S.p.A.
Via Puccini, 22
20010 Bettolino di Pogliano (Milano) Italy
Ph: (+39) 02-93960208 - Fax: (+39) 02-93960201
E-Mail: scotsman.europe@frimont.inet.it

Asia and Pacific
Scotsman Ice Systems-Frimont S.p.A. (R.O.)
321 Orchard Road #08-05
Singapore 238866
Ph: (+65) 738 5393 - Fax: (+65) 738 1959
E-mail: scotsicc@singnet.com.sg

China
Scotsman Ice Systems
258 Tong Ren Road Golden Tower 7A
Shanghai - 200040 Peoples's Republic of China
Ph: (+86) 21-62476056 - Fax: (+86) 21-62476126
E-mail: scotsmansh@online.sh.cn

