

MC 15
MC 45
MC1210

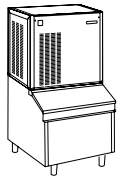

MC 45 with B 550
(sold separately)

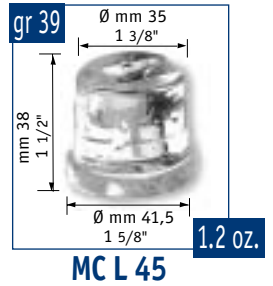
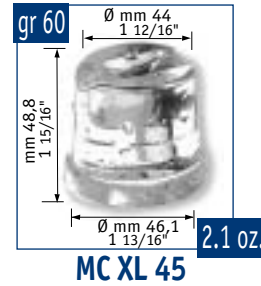
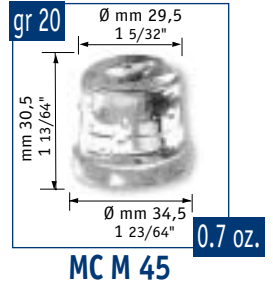
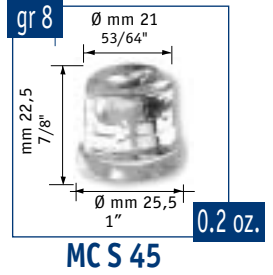
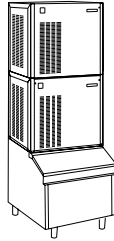

Double stack
(needs stacking kit sold separately)

**Modular
Gourmet-Cube
Ice Machine**

**Machine
Modulaire à
Glaçons
Gourmet**

**Kombi
Gourmetkegel-
eisbereiter**

**Màquina Modulare
Fabricadora
de Cubitos
Gourmet**

**Produttore
Modulare di
Ghiaccio a
Cubetti Gourmet**

Icon	+C° -C°	Ice Production						B550			[v/Hz/ph]	Dimensions		Ice Cube
		10°: 10°C			21°: 15°C			[kg]	[lbs]	N°		[WxDxH mm]	[WxDxH inches]	
		[kg]	[lbs]	N°*	[kg]	[lbs]	N°*							
MC S 45 AS	☼	280	616	35000	270	594	33750	230	506	28750	230/50/1-400/50/3N	1073x534x859	42"x 21"x33"	R 404 a
MC S 45 WS	☼	270	594	33750	260	573	32500	230	506	28750	230/50/1-400/50/3N	1073x534x859	42"x 21"x33"	R 404 a
MC M 45 AS	☼	310	683	15500	300	660	15000	230	506	11500	230/50/1-400/50/3N	1073x534x859	42"x 21"x33"	R 404 a
MC M 45 WS	☼	300	660	15000	290	640	14500	230	506	11500	230/50/1-400/50/3N	1073x534x859	42"x 21"x33"	R 404 a
MC L 45 AS	☼	295	650	7560	285	627	7550	230	506	5900	230/50/1-400/50/3N	1073x534x859	42"x 21"x33"	R 404 a
MC L 45 WS	☼	285	627	7310	275	606	7050	230	506	5900	230/50/1-400/50/3N	1073x534x859	42"x 21"x33"	R 404 a

*Estimate number of small, medium, large size gourmet cubes

www.scotsman-ice.com
www.scotsman-ice.it

2

Years Warranty
Ans de Garantie
Jahre Garantie
Años de Garantía
Anni di Garanzia

Subject to certain limitations and exclusions
Assujettie aux limites et exclusions prescrites
Abhängig von Bestimmten Einschränkungen und Ausnahmen
Sujeta a algunas limitaciones y exclusiones.
Soggetta ad alcune limitazioni ed esclusioni



This product qualifies for the following listings:



MC 45

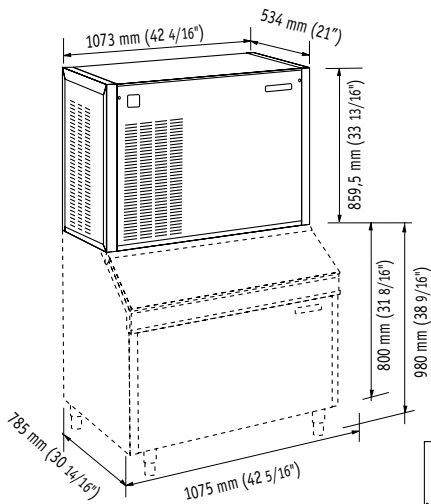

MC 45 (with B 550)

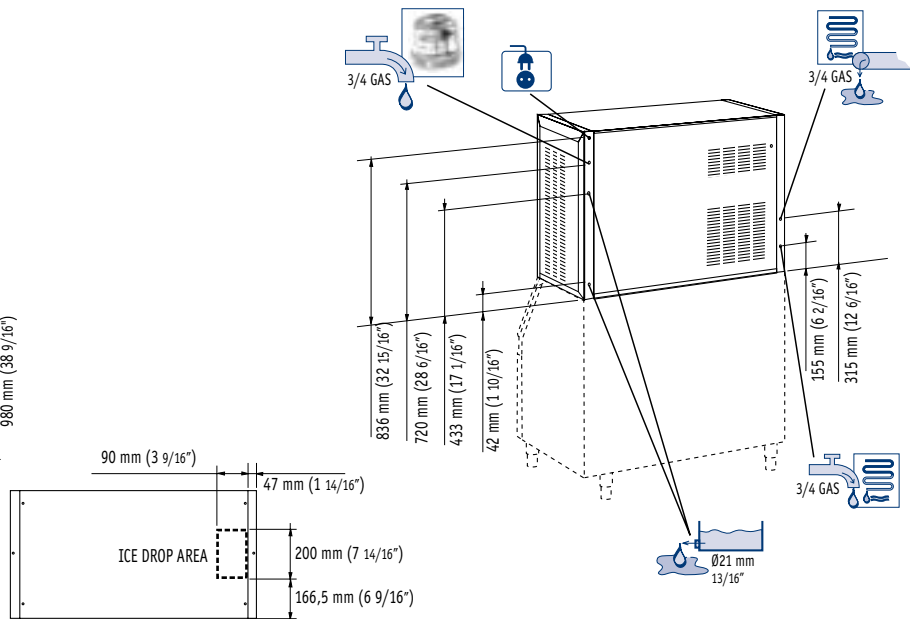

	-C° +C°	[Btu/h]	[W]	[Ømm ²]	[W]	FUSE [A]	[kWh]	24h [l/h]	32°C 90°F [gal/h]	[kg]	[lbs]	[kg]	[lbs]
MC S 45 AS		26000	7623	3x1.5 - 5x1.5	2400	20	50	27.5	7.2	110	242	125	275
MC S 45 WS		26000	7623	3x1.5 - 5x1.5	2400	20	50	215	56.7	105	231	120	264
MC M 45 AS		26000	7623	3x1.5 - 5x1.5	2400	20	50	27.5	7.2	110	242	125	275
MC M 45 WS		26000	7623	3x1.5 - 5x1.5	2400	20	50	215	56.7	105	231	120	264
MC L 45 AS		26000	7623	3x1.5 - 5x1.5	2400	20	50	27.5	7.2	110	242	125	275
MC L 45 WS		26000	7623	3x1.5 - 5x1.5	2400	20	50	215	56.7	105	231	120	264

MC M 45 AIR COOLED

MC M 45 WATER COOLED

°C	50°	60°	70°	90°	
10°	310	300	290	270	kg
50°	683	660	640	595	lbs
21°	300	290	280	260	kg
70°	660	639	616	573	lbs
32°	250	240	230	210	kg
90°	550	530	507	463	lbs
38°	220	210	200	180	kg
100	485	463	440	396	lbs

°C	50°	60°	70°	90°	
10°	300	290	280	260	kg
50°	660	640	617	573	lbs
21°	290	280	270	250	kg
70°	639	617	595	550	lbs
32°	280	270	260	240	kg
90°	616	595	573	530	lbs
38°	270	260	250	230	kg
100	595	573	550	507	lbs

Minimum	Maximum
10°C (50°F)	40°C (104°F)
5°C (41°F)	35°C (95°F)
-10%	+10%
1 BAR 14 psi	5 BAR 70 psi

Machine requires voltage indicated on rating name plate. Failures caused by improper voltage are not considered factory defects. Scotsman products are not designed for outdoor installation. Extended periods of operation at temperatures exceeding the above limitations constitutes misuse under the terms of Scotsman Limited Warranty, resulting in a loss.

La machine doit être raccordée conformément au voltage indiqué sur la plaque signalétique. Les éventuels dégâts causés par un non respect de cette consigne ne peuvent être considérés comme des défauts de fabrication. Les machines à glace Scotsman ne sont pas conçues pour être utilisées à l'extérieur. Le fonctionnement prolongé à des températures supérieures ou inférieures aux limites ci-dessus sont considérées comme une mauvaise utilisation dans le cadre de la garantie Scotsman.

Der Eisbereiter benötigt eine Stromspannung gemäß Geräte-Typenschild. Störungen oder Ausfälle, durch den Betrieb mit falscher Stromspannung sind keine Fabrikationsfehler und fallen nicht unter Garantie. Scotsman Eisbereiter sind nicht für die Installation im Freien geeignet. Der längere Betrieb bei Temperaturen über den obigen Grenzwerten ist eine falsche Anwendung und bedeutet den Verlust der Garantieleistung.

Los requerimientos eléctricos de la máquina están indicados en la placa de características. Los daños causados por voltajes inadecuados no son considerados defectos de fábrica. La máquinas de hielo Scotsman, no están diseñadas para trabajar a la intemperie. Largos periodos de funcionamiento a temperaturas que excedan de las limitaciones indicadas, constituyen maltrato de acuerdo con las observaciones de Scotsman.

La macchina richiede il voltaggio indicato sulla targhetta di identificazione. Danni causati da voltaggi diversi non sono considerati difetti di produzione. I prodotti Scotsman non vanno utilizzati all'aperto. Un prolungato periodo di utilizzo al di fuori delle temperature indicate non è consentito e causa l'automatico decadere della garanzia.



Scotsman[®]
Ice Systems

The one the world relies on.

Certified ISO 9001:2000

USA, Canada, Latin America

Scotsman Ice Systems USA
775 Corporate Woods Parkway
Vernon Hills, IL 60061
Ph: (+1) 847 215-4550
Fax (+1) 847 913-9844
customer.service@scotsman-ice.com

Europe

Scotsman Europe-Frimont S.p.A.
Via Puccini, 22
20010 Pogliano (Milano) Italy
Ph: (+39) 02-93960208
Fax: (+39) 02-93960201
scotsman.europe@frimont.it

Asia and Pacific

Scotsman Ice Systems-Frimont S.p.A. (R.O.)
627A Aljunied Road-#04-04 Biztech Centre
Singapore 389842
Mobile: Ph: (+65) 6738 5393
Fax: (+65) 6738 1959
scotsice@singnet.com.sg

China

Scotsman Ice Systems
258 Tong Ren Road Golden Tower 7A
Shanghai-200040 Peoples Republic of China
Ph: (+86) 21-62476056
Fax: (+86) 21-62476126
scotsmansh@online.sh.cn

Middle East & N. Africa

Scotsman Ice Systems Dubai Office
P.o. Box 13205 - Deira
Dubai - U.A.E.
Mobile: Ph: (+971) 505505980
Fax (+971) 6-5654063
scotsman@emirates.net.ae

South Africa

Scotsman Ice Systems SA (PTY) Ltd.
10, Rhodes Street - Kensington B
P.o. Box 44 - Riverclub 2149
Ph: (+27) 11-7898400
Fax (+27) 11-7898411
scotsman@telkomsa.net